



# INSTALLATION INSTRUCTIONS

Accessory  
**CARGO NET**  
P/N 08L96-SZA-100

Application  
**2009 PILOT**

Publications No.  
**All 39414**  
Issue Date  
**MAY 2008**

Put this information in the glove box with the vehicle owner's manual.

## PARTS LIST

Cargo net

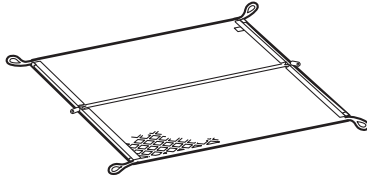

4 Snaps

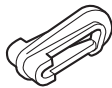

## TOOLS AND SUPPLIES REQUIRED

Small flat-tip screwdriver

## INSTALLATION

### NOTE:

- Some luggage stored in the cargo net may interfere with the tailgate when it is closed. To prevent damage to the cargo net, do not store large or fragile articles in the cargo net.
- Before storing articles that have sharp edges or corners, wrap them with paper or in a blanket so their sharp edges or corners will not contact the cargo net directly.

## Installing the Cargo Net in the Horizontal Position

1. Using a small flat-tip screwdriver, push and release the seat belt lower hook from each third row seat. Insert the seat belt lower hook to the fix hole.

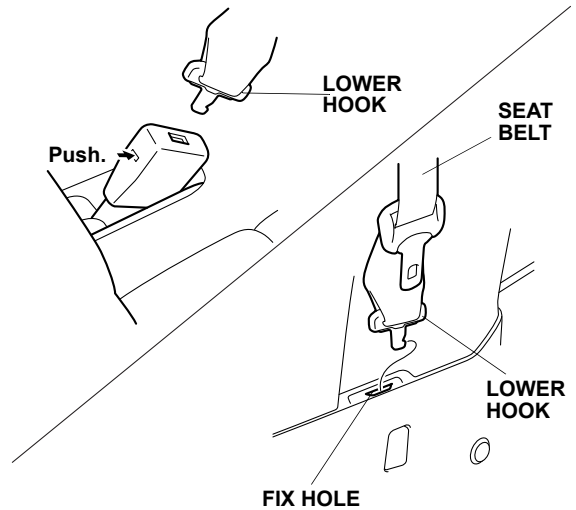

2. Attach four snaps onto the cargo net as shown.

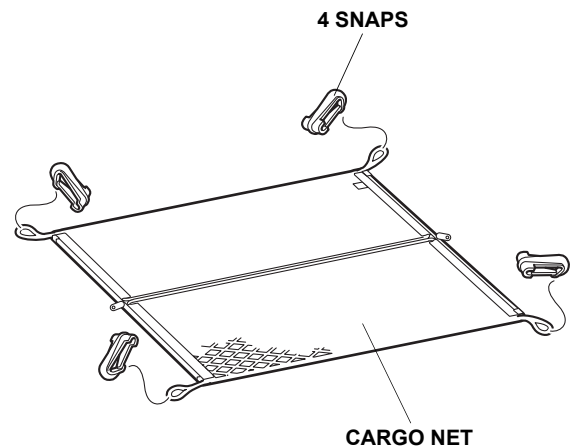

3. Fold down the third row seats.

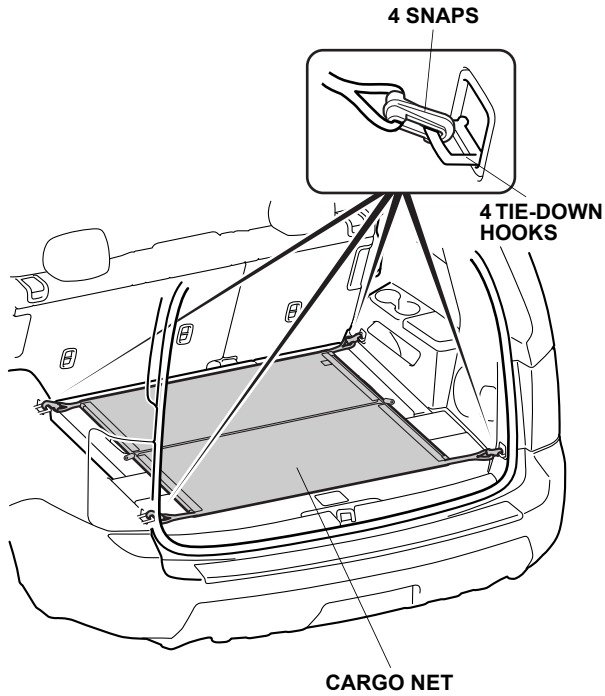

4. Attach four snaps of the cargo net to the four tie-down hooks in the cargo area.

#### Installing the Cargo Net in the Vertical Position

5. Fold the cargo net and zip up the two zippers on each side.

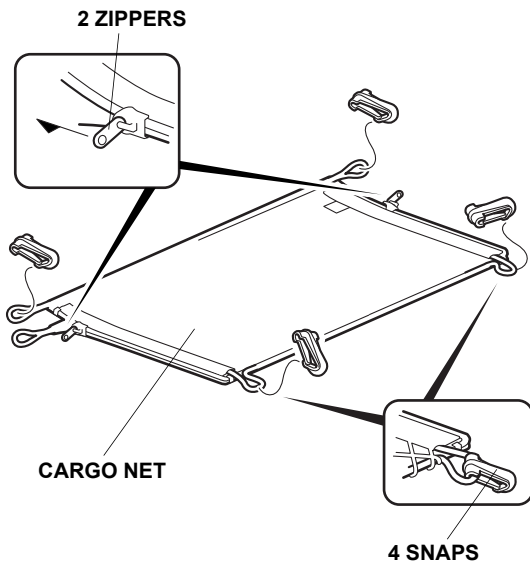

6. Attach four snaps onto the cargo net as shown.

7. Attach the upper two loops on the cargo net to the two anchors. Then attach the two upper snaps on the cargo net to the two upper loops as shown.

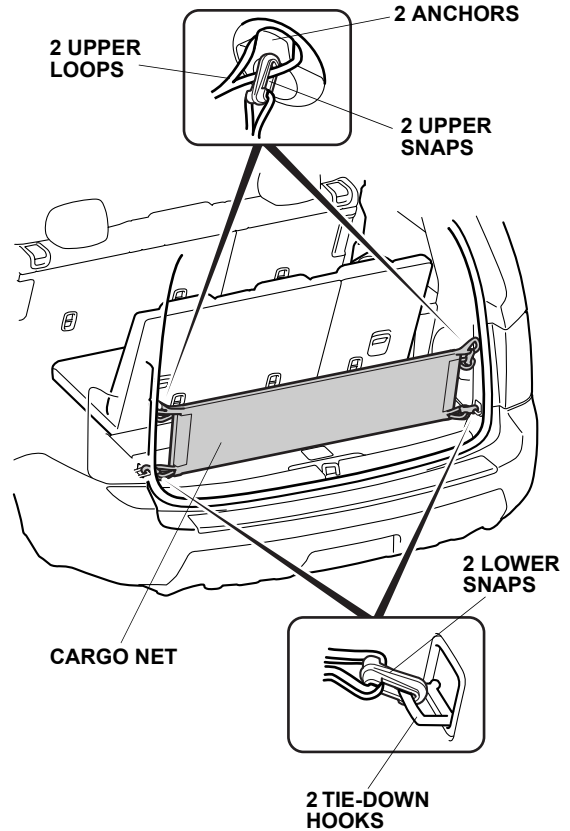

8. Attach the two lower snaps on the cargo net to the two tie-down hooks.